

GRReddy®

GRReddy Intercooler Kit

(Type 31)

'99-'00 Honda Civic Si (B16A)



'99-'00 Honda Civic Si (B16A)

Installation Manual

Please read the entire manual before installing this kit.

Application:

Make	Model	Chassis	Year
Honda	Civic Si	EM1	99~00

- This *GReddy Intercooler Kit* is designed only for the vehicles specified above with the *GReddy Civic Si Turbo Kit TD-05 18G*.

1. Parts List

1.	Intercooler	(T E H 3 1)							1
2.	Intake pipe	I_1	(5 0 ϕ Aluminum)						1
3.	Intake pipe	I_2	(6 0 ϕ Aluminum)						1
4.	Hose	5 0 ϕ \times 7 0 mm	Straight						1
5.	Hose	6 0 ϕ \times 7 0 mm	Straight						1
6.	Hose Band	5 0 ϕ	3 2 #						2
7.	Hose Band	6 0 ϕ	3 6 #						2
8.	Intercooler Bracket								1
9.	8 mm \times 1 5 mm	P 1. 2 5	Stainless	B	S / W	F / W	_		1
1 0.	8 mm \times 2 0 mm	P 1. 2 5	Stainless	B	S / W	F / W	N		1
1 1.	6 mm \times 1 5 mm	P 1. 0	Stainless	B	S / W	F / W	_		1

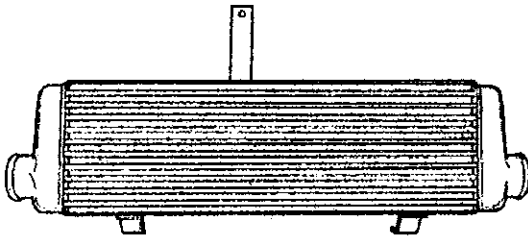

1

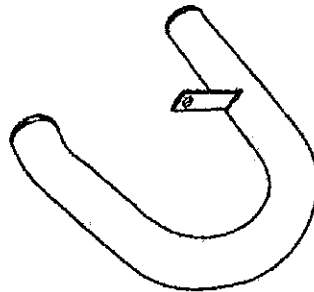

2

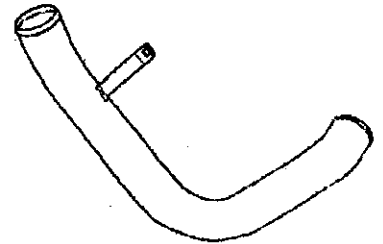

3

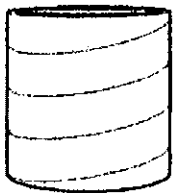

4-5

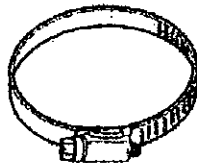

6-7

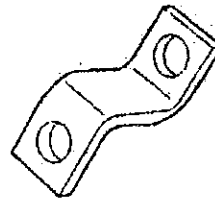

8

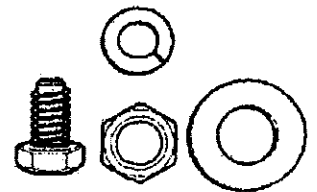

9-11

2. Removal of Stock Parts

When removing the stock parts, make sure you read over the factory repair manual for proper procedures.

- 2-1 Disconnect the negative side of the battery.
- 2-2 Remove the undercover, and the front bumper.
- 2-3 Remove all the piping from the turbo to the throttle body.

3. Kit Installation

3-1 Intercooler Core Installation

Install the Intercooler Bracket to the sub-member support with the horn as shown.

(Parts used #8,9)

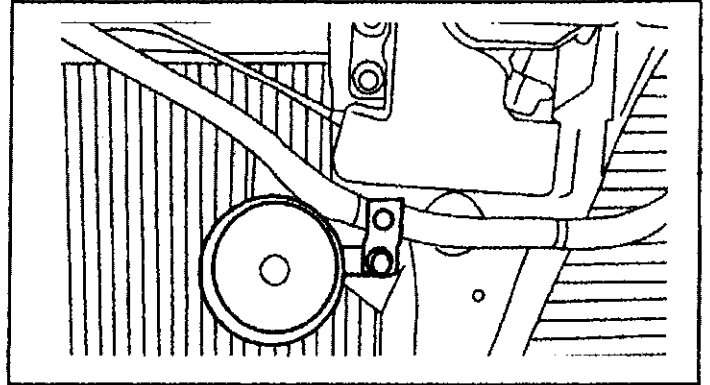

Mount the top bracket of the intercooler to the Intercooler Bracket .

(Parts used #1,10)

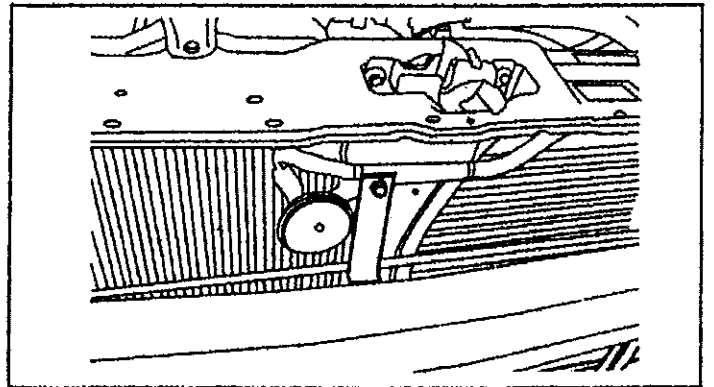

Mount the bottom bracket to the front bumper mounting hole with factory bolts.

(The bumper will be mounted with the intercooler bracket at the very end of the installation.)

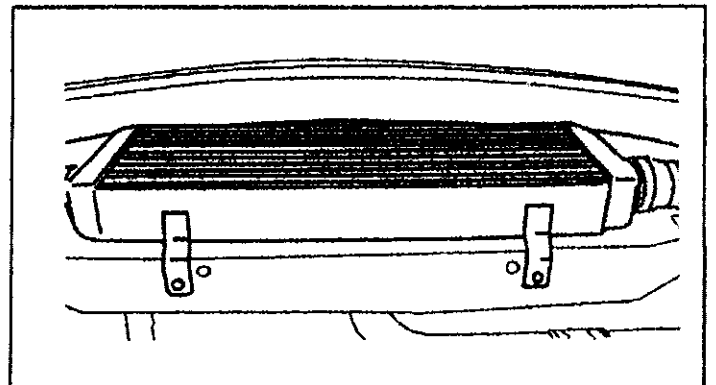

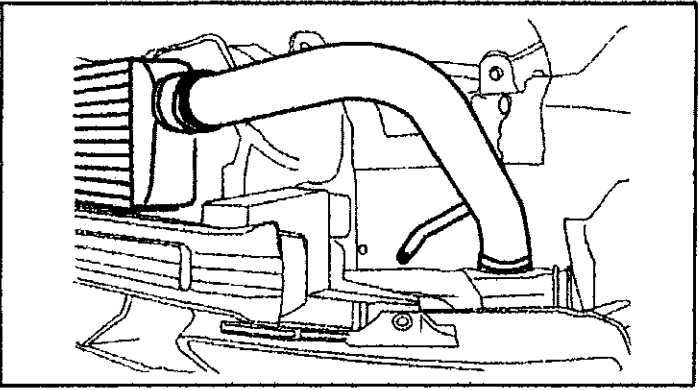
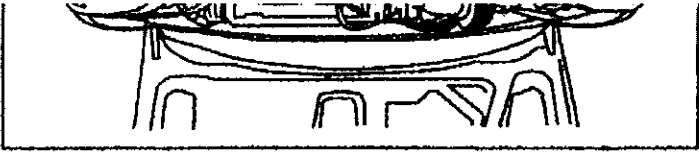

3-3 Intake Pipe Installation (out)
(1) Install I-2 pipe between the intercooler outlet, and C-3 pipe from the turbo kit. Secure the bracket to the chassis as shown.
(Parts used # 3, 5, 7, 11)

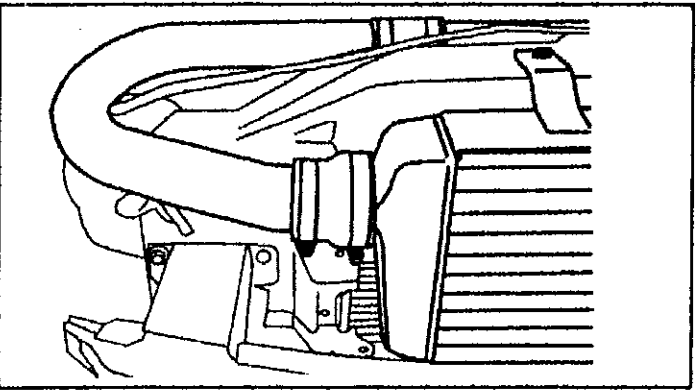

(3) Connect the L-1 pipe to the intercooler inlet using 50mm hose.
(Parts used # 4, 6)

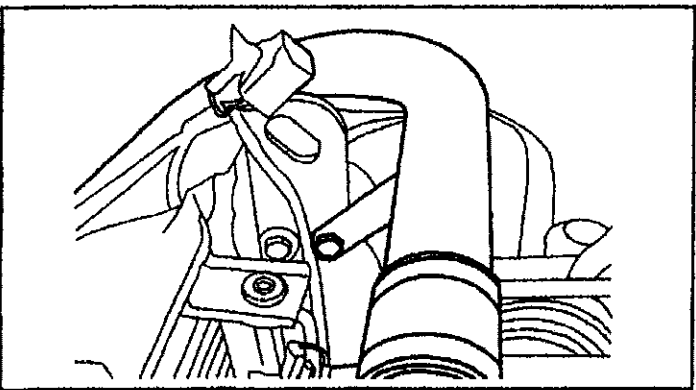

(2) Secure the bracket on the L-1 to the toe hook as shown.

3-5 Left Inner Fender Cover Modification

Trim the shaded area of the Left Inner Fender Cover as shown in the illustration. Do the same for the right side. Make sure that the piping clears the cover.

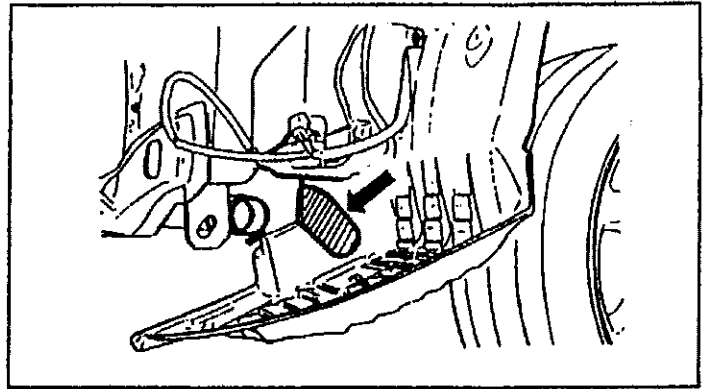

3-6 Front Bumper modification

Trim the shaded area of the front bumper. Match it up with the intercooler core and piping when cutting.

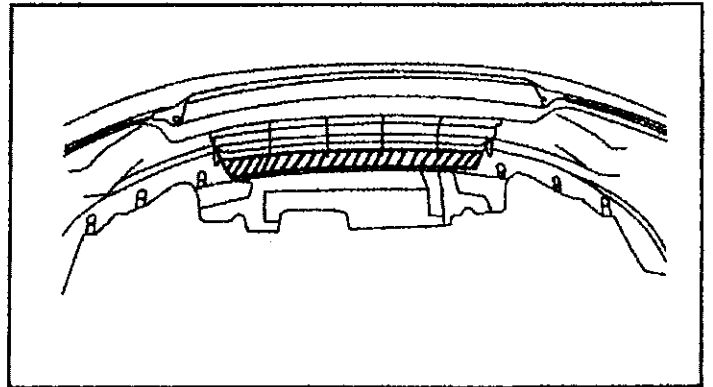

3-7 Front Bumper Installation

Reinstall the front bumper using original bolts.
*The bolts holding the bottom intercooler bracket will have to be removed once to install the bumper.

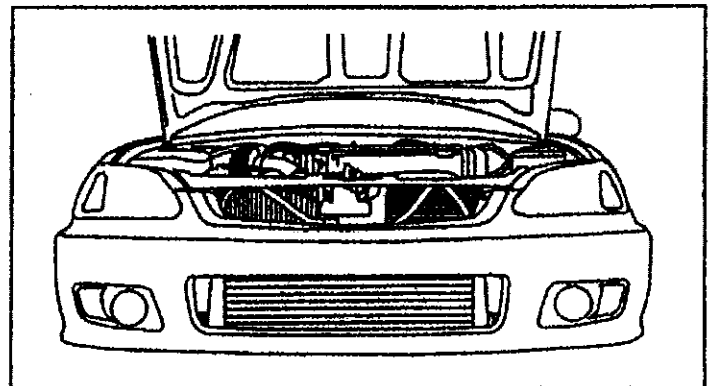

Starting the Engine

- (1) Check all the pipe and hose connections, then reconnect the negative side of the battery.
- (2) Start the engine. While idling, check for any air leaks.
- (3) After inspection, reinstall the front bumper, under cover and other stock parts that was removed.
- (4) Secure the bottom of the bumper with the intercooler bracket.
- (4) Make sure that all the lamps work properly.

This completes the Intercooler Kit installation.