

GRReddy®

GRReddy Intercooler Set-Up Kit

(Type 31)

Acura Integra GSR DC2 (B18C)



Acura Integra GSR DC2 (B18C)

Installation Manual

Please read the entire manual before installing this kit.

Application:

Make	Model	Chassis	Year
Acura	Integra GSR	DC2	94~99

- This *GReddy Intercooler set-Up Kit* is designed only for the vehicles specified above.
- This kit requires a fabrication of the turbo compressor out let pipe, to connect the turbocharger to the intercooler inlet pipe.

1. Parts List

1.	Intercooler	(Type 31)	1
2.	Intercooler pipe I-1	(Steel 50Ø)	1
3.	"	I-2 (Steel 60Ø)	1
4.	"	I-3 (Steel 60Ø)	1
5.	Rubber Hose	60Ø X 70mm	2
6.	Reducer Hose	50Ø X 60Ø	1
7.	"	60Ø X 65Ø	1
8.	Hose Band	50Ø #32	1
9.	Hose Band	60Ø #36	6
10.	Hose Band	56Ø #40	1
11.	Aluminum Spacer	t=8	1
12.	Zip ties		10
13.	M6 X 15	P=1.0 B S/W F/W N	2
14.	M6 X 20	P=1.0 B S/W F/W -	1

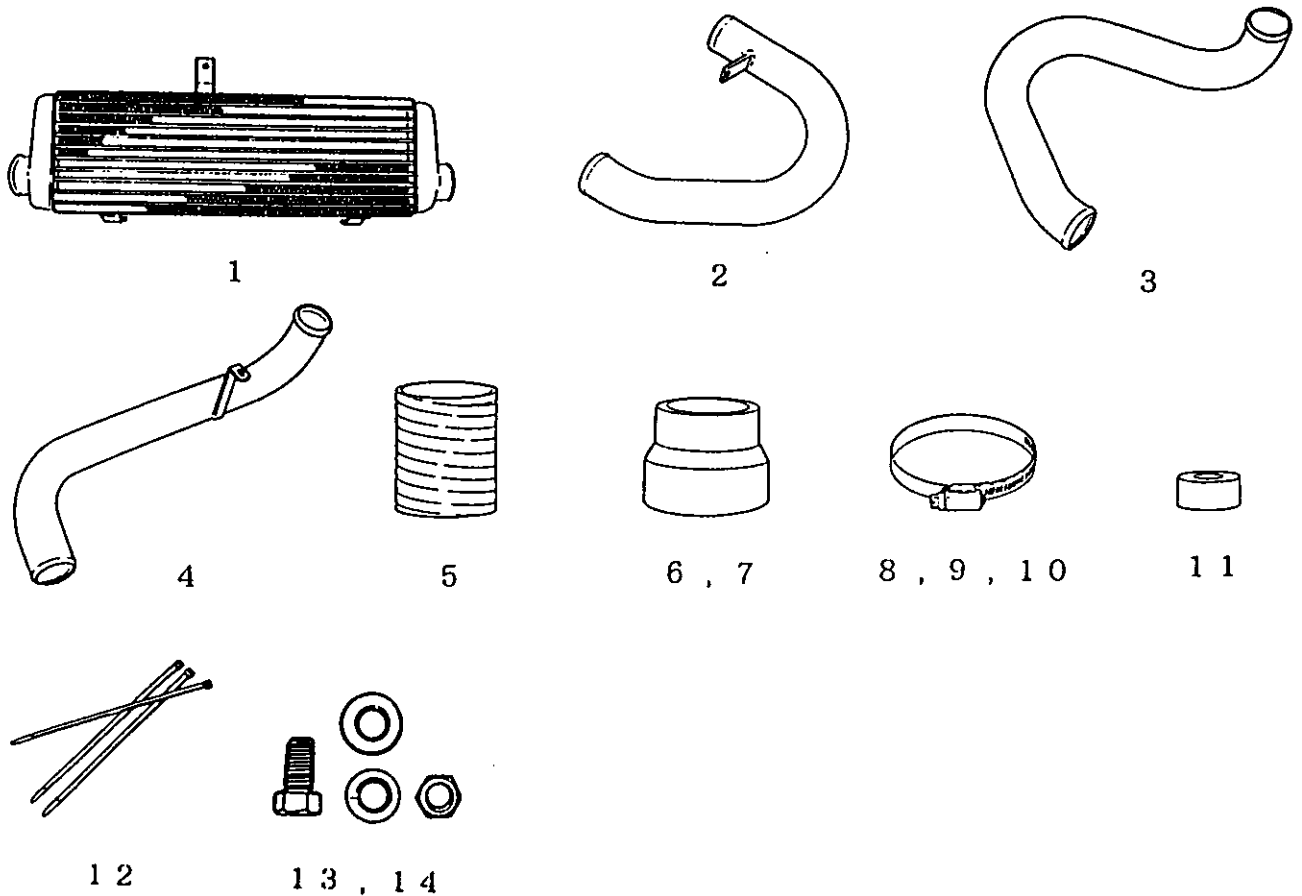

2. Removal of Stock Parts

When removing the stock parts, make sure you read over the factory repair manual for proper procedures.

- 2-1 Disconnect the negative side of the battery.
- 2-2 Remove the undercover, and the front bumper.
- 2-3 Remove all the piping from the turbo to the throttle body.

3. Kit Installation

3-1 A/C tube and P/S oil cooler line modification

- (1) Remove the A/C condenser tube in the front of the vehicle off from the clip, and the mounting bolts for the P/S oil cooler tube.

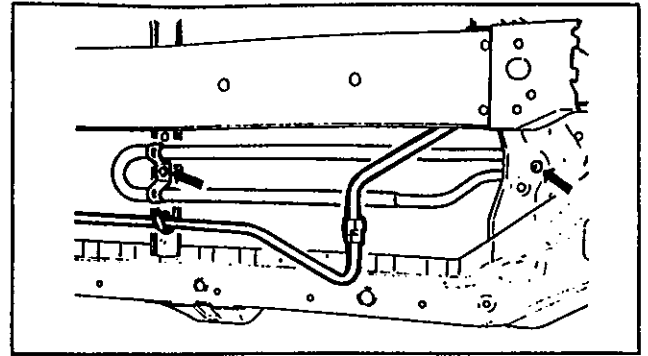

- (2) Bend the A/C tube and tuck it behind the P/S oil cooler tube as shown. Then remount the P/S oil cooler back to the original location.

* Be careful not to crush or kink the tube when bending.

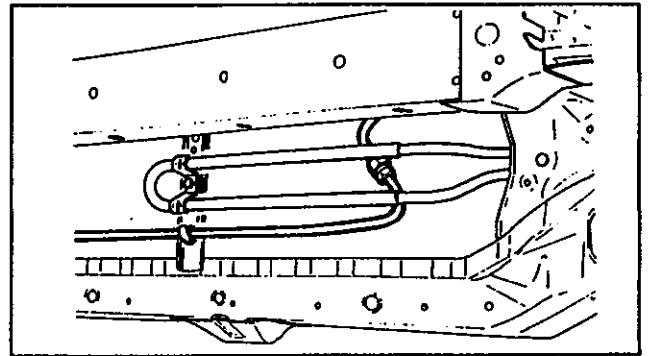

3-2 Intercooler Core Installation

Mount the intercooler in front of the A/C condenser.

(Parts used #1, 11, 13, 14)

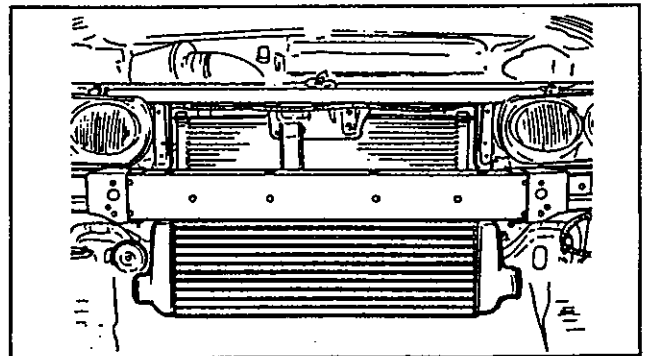

Mount the top bracket of the intercooler to the sub-member support using provided aluminum spacer and M6 X 20 bolt and nut.

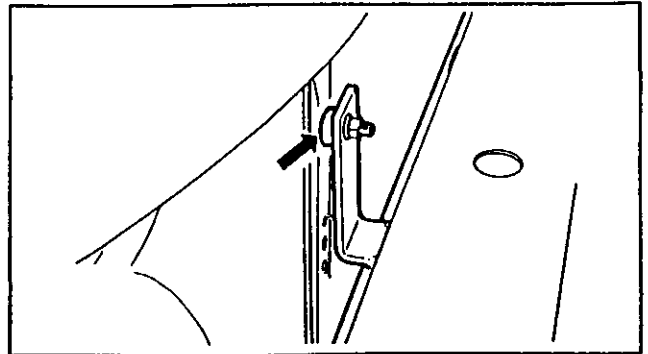

Mount the bottom bracket to the front bumper mounting hole.

(The bumper will be mounted with the intercooler bracket at the end.)

- * Make sure that the intercooler core does not rub up on the P/S oil cooler tube.

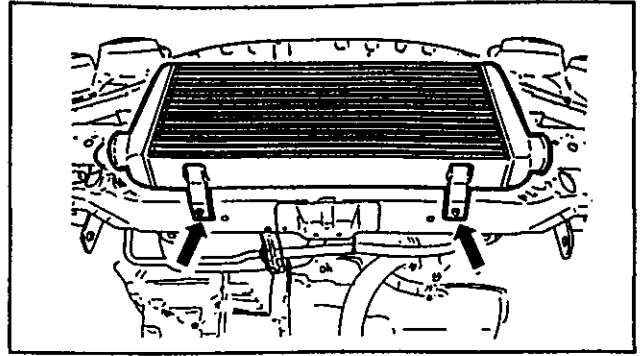

3-3 Intercooler Pipe Installation (in)

- (1) Secure the A/C hose located on the bottom of the vehicle to the radiator lower tank with a Zip Tie as shown.
(Parts used #12)

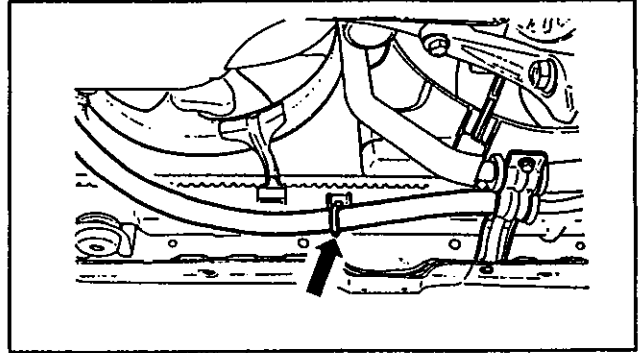

- (2) Install the Intercooler Pipe I-1 to the inlet of the intercooler, and secure the bracket to the toe hook.
(Parts used #2, 6, 8, 9)

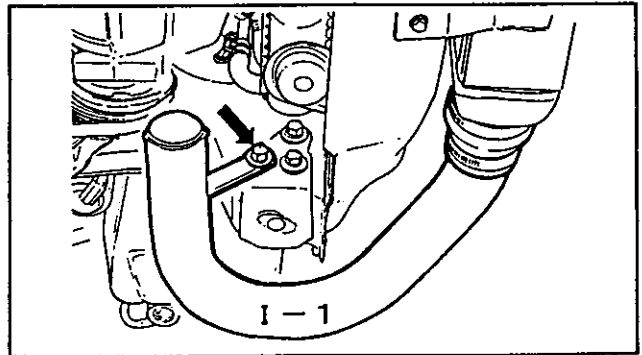

3-4 Intake Pipe Installation (out)

- (1) Bend the two A/C tube over to the left side of the engine bay (towards the ABS valve). Make sure not to crush or kink the tube.

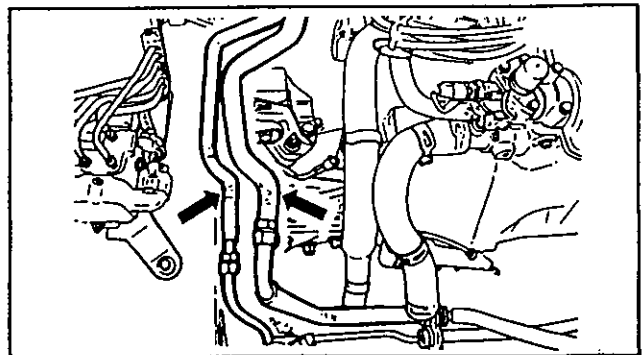

- (2) Remove the harness clamp bracket on the top of the starter motor.

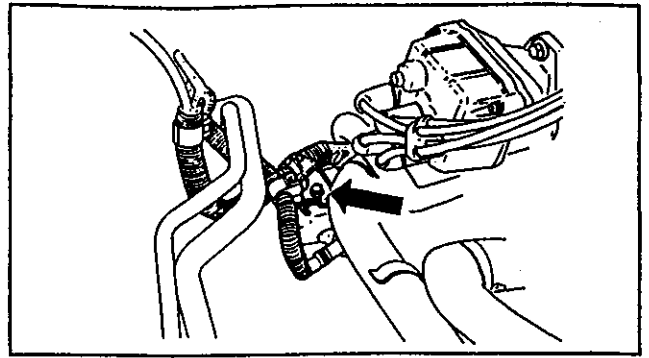

- (3) Install the Intercooler pipe I-2, and I-3 between the intercooler and the throttle body.

(Parts used #3, 4, 5, 7, 9, 10)

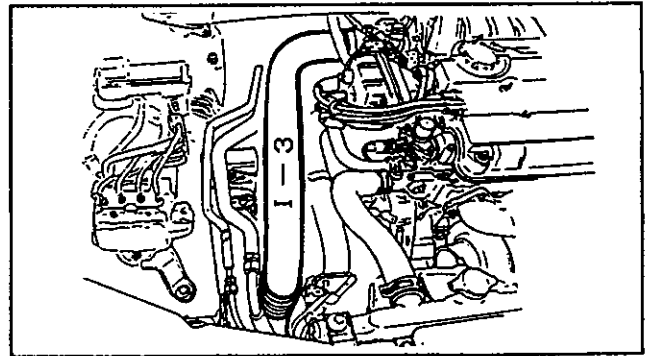
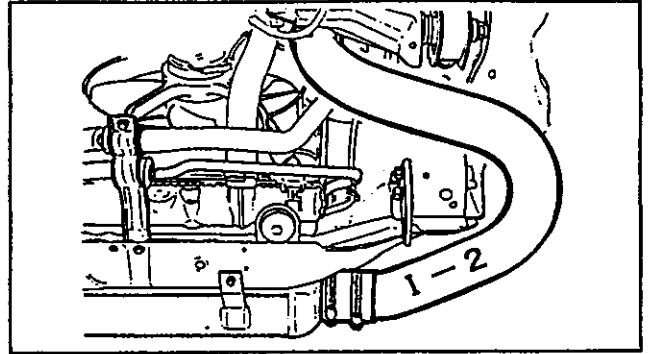

- (4) Secure the intercooler pipe I-3 bracket to the lower radiator hose clamp base plate. Bolt it down with factory bolt next to the transmission ground wire.

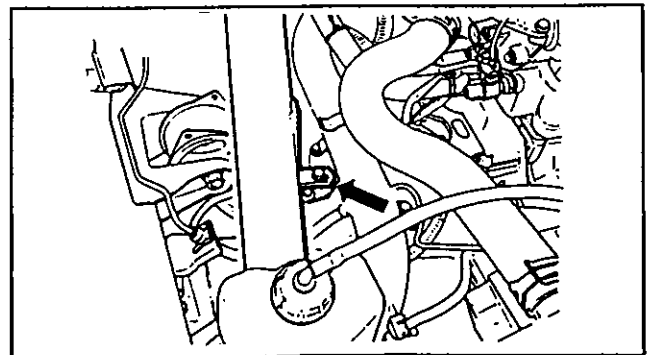

- 3-5 Left Inner Fender Cover Modification**
Trim the shaded area of the Left Inner Fender Cover as shown in the illustration.
Match it up with the intercooler pipe I-1.

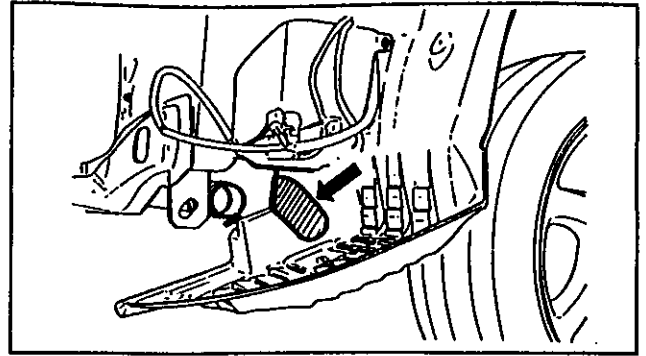

- 3-6 Front Bumper modification**
Trim the shaded area of the front bumper, and the signal light brackets as shown below.
Match it up with the intercooler core and piping when cutting.

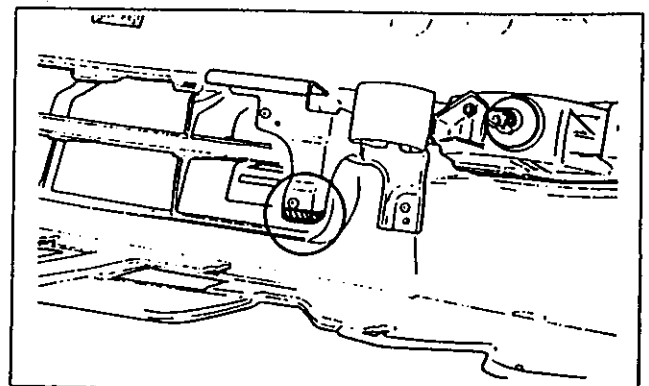
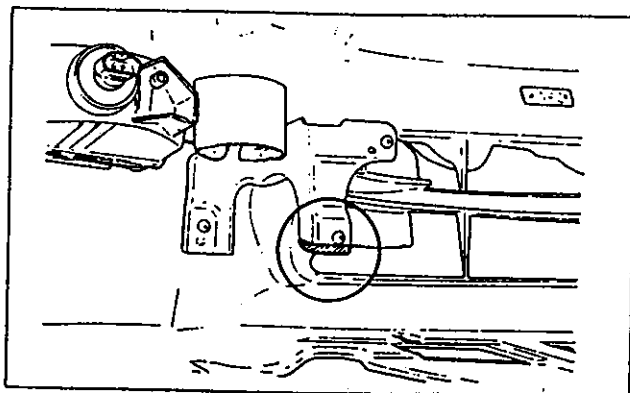
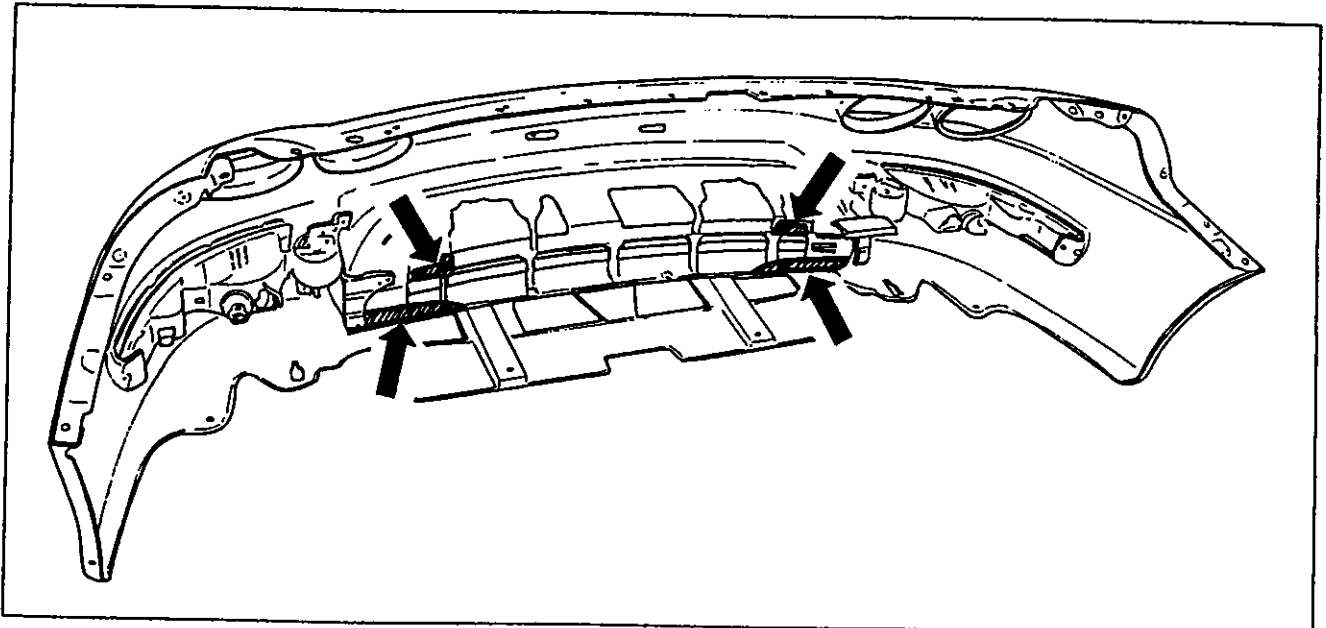

- 3-7 Under Cover Modification**
Trim the shaded area of the Under Cover as shown. Match it up with the intercooler pipe.

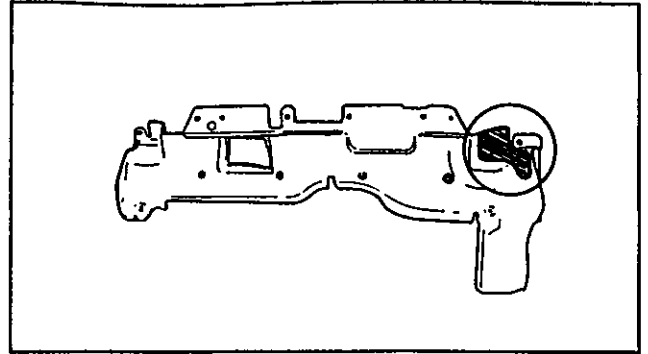

- 3-8 Fabrication of intake pipe**
Fabricate a pipe to connect the turbo out-let to the Intercooler Pipe I-1.

Starting the Engine

- (1) Check all the pipe and hose connections, then reconnect the negative side of the battery.
- (2) Start the engine. While idling, check for any air leaks.
- (3) After inspection, reinstall the front bumper, under cover and other stock parts that was removed.
 - * Secure the bottom of the bumper with the intercooler bracket.
- (4) Make sure that all the lamps work properly.

This completes the Turbo Kit installation.